

MODELS-1061/S, 1062/S, 1063/S, 1064/S



Low Pressure Stainless Steel Case Draught Gauges.

APPLICATIONS

1060 series Low pressure gauges are designed for the petrochemical, refrigeration, HVAC, industrial gases and ventilation industries.

Suitable for use on Dry Air & Gas only.

STANDARD SPECIFICATION

(Weatherproof Construction to IP66)

Sizes

63, 100 and 150 mm

Case/ Bezel

316 Stainless Steel

Socket & Element

316 Stainless Steel or Brass (316 Stainless Steel BeCu Element)

Movement

Brass

Blowout Protection

Blow-out plug at the top of the case

Dial

White Anodised Aluminium (Black Printing)

Pointer

Black Aluminium

Window

Sheet Glass

Traceability

All instruments are individually calibrated and have an unique Serial Number.

Certification available on request

- Certificate of Conformity Traceable to National Standards
- Group Certification (Pressure Test Calibration Statement)
- Point to Point Test Certificate
- BS EN 10204 3.1 Material Certification

Safety

All units are manufactured to comply with EN 837-3, S1 Blowout device specification and other regulatory standards including PED 2014/68/EU.

Installation instructions

Refer to EN 837-2 and our [Guidance On Use of Equipment](#) data sheet.

Accuracy class

ACCURACY CLASS EN837-1 (Optional)		
	-400 - 0 mbar	0 - 400 mbar
63mm	1.6 (1.0)	1.6 (1.0)
100mm	1.6 (1.0)	1.6 (1.0)
150mm	1.6 (1.0)	1.6 (1.0)

1.25% Accuracy on request (Consult Sales)

Other Ranges on request (Consult Sales)

Over-pressure

1.25 x FSD

Scale Range

Pressure 0-10, 0-16, 0-25, 0-40, 0-60, 0-100, 0-160, 0-250 & 0-400 mBar

Vacuum / Compound to -400 mbar to 0 to -100 to 300 mbar (where applicable)

Or other equivalent units of pressure or vacuum

Pressure Connection Thread

1/8", 1/4", 3/8", 1/2" NPT, BSP, BSPT

Model-1062/S Direct Mounted



Model-1061/S Surface Mounted (Bottom Connection)

Model-1062/S Direct Mounted (Bottom Connection)

Model-1062/S-BC Direct Mounted (Rear Connection)

Model-1063/S Flush Mounted Screw Fixing (Rear Connection)

Model-1064/S Flush Mounted Clamp Fixing (Rear Connection)

[See Page-2 for dimension](#)

Operating Temperature Range EN837

-20° to 60°C (-4°F to 140°F)

[Options for lower/Higher operating ranges \(Contact Sales\)](#)

Temperature Error

Additional error when temperature changes from reference

Temperature of 20°C (68°F) ±0.4% for every 10°C (18°F) rising or Falling % of span

Optional Extras

- Slot adjustable pointer /Black finish
- Optional dial materials & Custom markings
- Monel according to ISO 15156 / NACE MR-01-75 wetted parts
- Other pressure connections
- Laminated safety glass or Perspex window
- Orifice Restrictor Screw (standard Ø0.9mm, Ø0.4mm on request)
- Customer logo printed on dial
- Nitelitegage® (See data sheet)
- Safety Pattern Type with Baffle wall, EN837-1, S3 (Dimensions available on request)
- Gauge over-pressure up to 130% of FSD
- Full Vacuum Protection on positive ranges (Where applicable, with Nested type capsule)
- 10x Overpressure (Where applicable, with special capsule assemblies)

[Further options on request](#)

Available with a wide range of accessories

Snubbers, Overrange gauge protectors, Valves, Manifolds, Swivel adaptors, etc ensures that STEWARTS can provide you with the right product to suit any individual application or requirement.

Ordering Parameters, Please state the following: SIZE, MODEL NO, SCALE RANGE, CONNECTION, PRESSURE MEDIUM & OPTIONAL EXTRAS

MODELS-1061/S, 1062/S, 1063/S, 1064/S

Low Pressure Stainless Steel Draught Gauges.

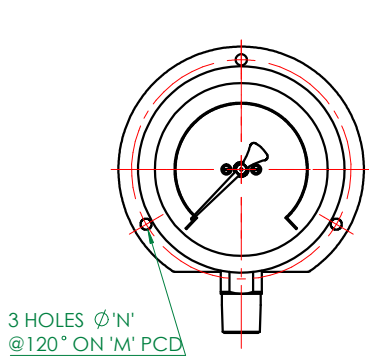

**MODEL 1061/S
SURFACED MOUNTED**

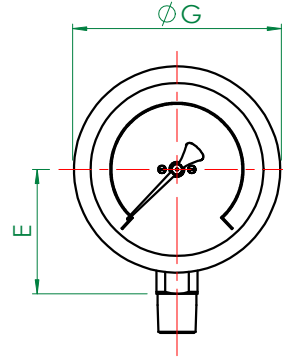
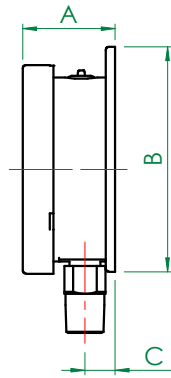

**MODEL 1062/S
DIRECT MOUNTED (STANDARD)**

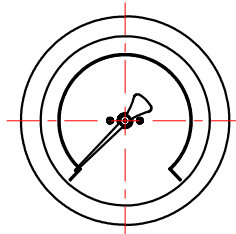
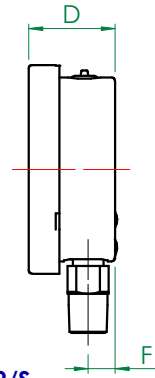

**MODEL 1062/S-BC
DIRECT MOUNTED - REAR CONNECT**

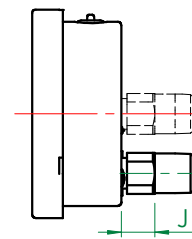

CENTRE BACK
LOWER BACK
(DEPENDANT ON RANGE & MATERIALS.)

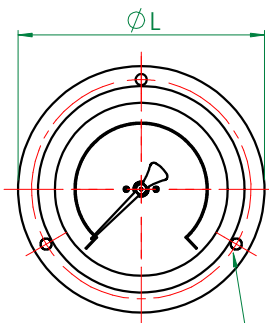

**MODEL 1063/S
FLUSH MOUNTED - SCREW FIXING**

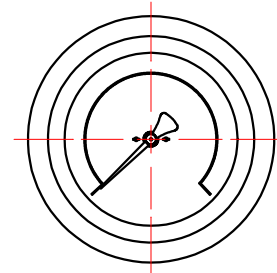
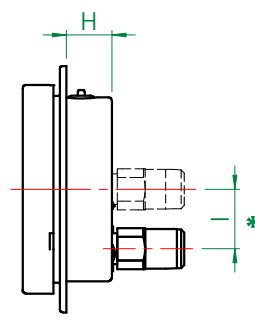

**MODEL 1064/S
FLUSH MOUNTED - CLAMP FIXING**

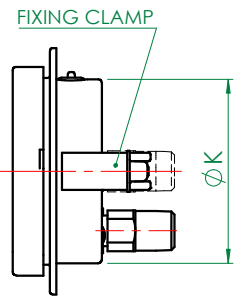

General Arrangement Dimensions in mm, tol' ± 1mm																	
Dim	A	B	C	D	E	F	G	H	I*	J	K	L	M	N	O	Panel cut-out	
2.5" (63mm)	34	78.5	12.5	38	42	9.5	68.5	21.5	18	12.5	62	85	75	3.5	3.8	66	
4" (100mm)	50	121	17	48.5	67	15	112	24.5	32	18	99	132.5	118	6	6	106	
6" (150mm)	50	174	17	48.5	92	15	162	24.5	32	18	148	185	168	5.8	5.8	153	

* REAR CONNECTION CAN BE EITHER CENTRE BACK OR LOWER BACK (SHOWN) DEPENDANT ON RANGE & MATERIALS.

STEWART-BUCHANAN GAUGES LTD

Sales Office & Manufacturing Facility - 7 Garrel Road, Burnside Industrial Estate, Kilsyth, Glasgow G65 9JX, SCOTLAND
Tel: +44 (0)1236 821533 | Fax: +44 (0)1236 824090 | E-mail: sales@stewarts-group.com | Web: stewarts-group.com

DATA SHEET REF: 106-REV02-17

